

Wiring for UHF Transmitters

The diagrams shown on page 3 represent the basic wiring necessary for the most common types of microphones and other audio inputs. Some microphones may require extra jumpers or a slight variation on the diagrams shown.

If you encounter a microphone that differs from or is not included in these instructions, please call our toll-free number or visit our web site at: www.lectrosonics.com

Component Parts

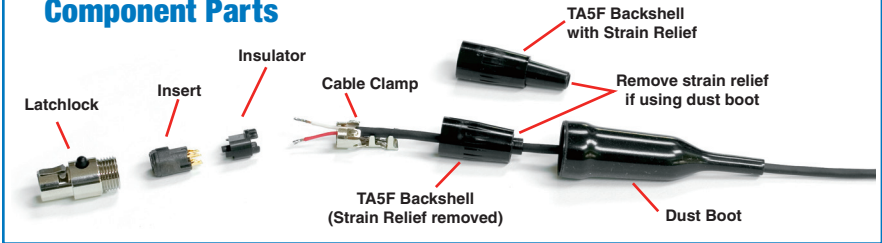

Installing the Connector:

- 1) If necessary, remove the old connector from microphone cable.
- 2) Slide the **Dust Boot** onto microphone cable as shown. Remove the **Strain Relief** from the backshell (if present).
- 3) If necessary, slide the supplied 1/8-inch diameter black shrink tubing onto the microphone cable to ensure that the cable fits snugly in the **Dust Boot**.
- 4) If required, use the resistors included with this kit to configure the TA5F to your particular microphone according to the wiring diagrams on page 3.

Resistors included:

- Two 1.5K ohm (shorter leads)
- Two 3.32K ohm (longer leads)



NOTE: The resistors may also be supplied on a card with the values indicated.

The resistors are soldered onto the wires as indicated in the diagrams on page 3.



Slide a length of the supplied .065" OD clear tubing over the resistor and wire before soldering the resistor to the pin.

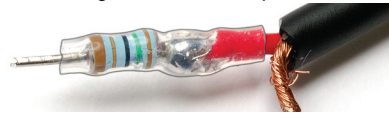

- 5) Run the wires through the **Insulator** and solder the resistors to the correct pins on the **Insert** as indicated in the diagrams.



- 6) Align the flat sides and attach the **Insulator** to the **Insert**.
- 7) Slide the **Cable Clamp** over the wires and attach it to the insert. Crimp the fingers as shown on the following page, leaving a little slack in the wires between the fingers and the insert.
- 8) Slide the completed assembly into the **Latchlock**. Orient the tab on the **Insert** to align with the notch in the **Latchlock** to allow it to fully seat. Thread the **Backshell** onto the **Latchlock** and tighten it.

Microphone Cable Termination for Non-Lectrosonics Microphones

TA5F Connector Assembly

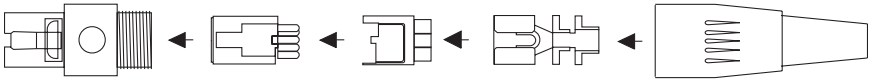

Cable Stripping Instructions

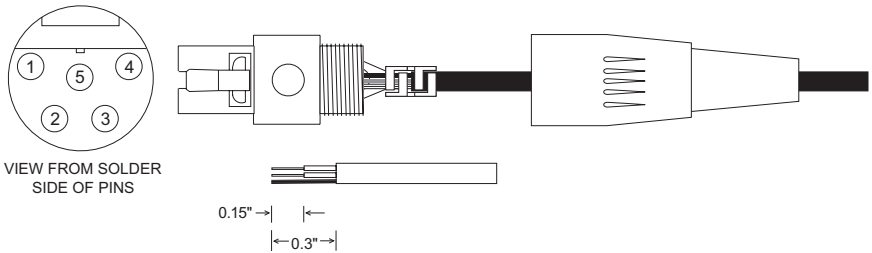

Crimping to Shield and Insulation

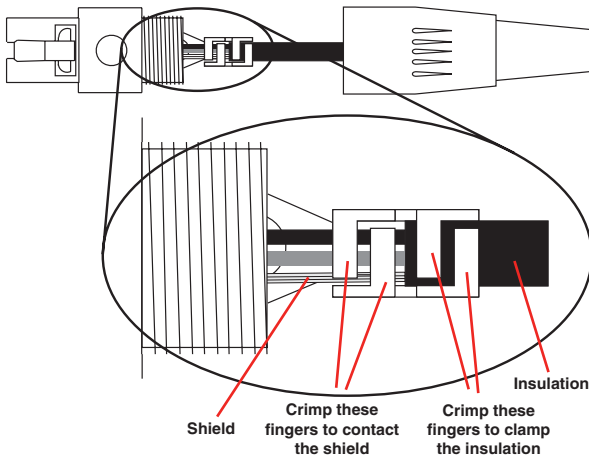

Strip and position the cable so that the clamp fingers can be crimped to contact both the mic cable shield and the insulation. The shield contact reduces noise with some microphones and the insulation clamp increases ruggedness.

NOTE: This termination is intended for UHF transmitters only. VHF transmitters with 5-pin jacks require a different termination. Visit the website for details. Search: "mic wiring."

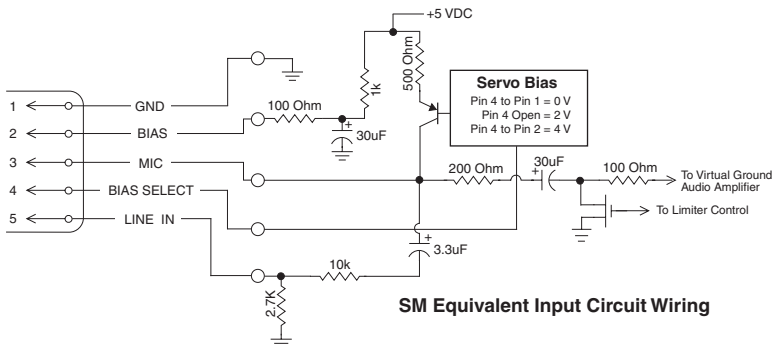

SM Equivalent Input Circuit Wiring

Wiring Hookups for Different Sources

In addition to the microphone and line level wiring hookups illustrated below, Lectrosonics makes a number of cables and adapters for other situations such as connecting musical instruments (guitars, bass guitars, etc.) to the transmitter. Visit www.lectrosonics.com and click on Accessories, or download the master catalog.

A lot of information regarding microphone wiring is also available in the FAQ section of the web site at:

<http://www.lectrosonics.com/faq.htm>

Follow the instructions to search by model number or other search options.

Compatible Wiring for Both Servo Bias Inputs and Earlier Transmitters:

Fig. 1

2 VOLT POSITIVE BIAS 2-WIRE ELECTRET

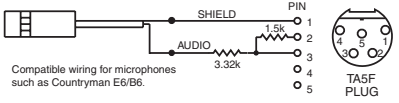

Fig. 2

4 VOLT POSITIVE BIAS 2-WIRE ELECTRET

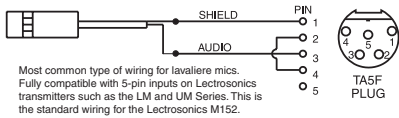

Fig. 3

DPA MICROPHONES (Danish Pro Audio miniature models)

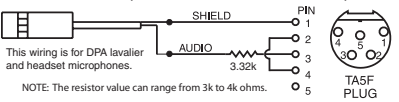

Fig. 4

2 VOLT NEGATIVE BIAS 2-WIRE ELECTRET

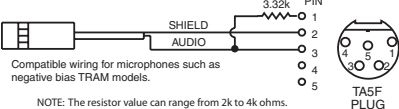

Fig. 5

4 VOLT POSITIVE BIAS 3-WIRE ELECTRET WITH EXTERNAL RESISTOR

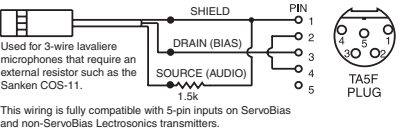

Fig. 6

LO-Z MICROPHONE LEVEL SIGNALS

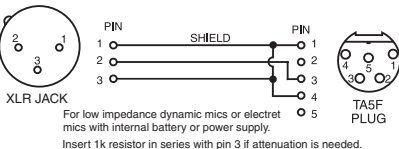
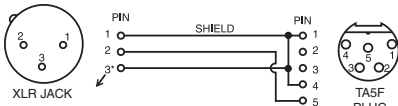

Fig. 7

BALANCED AND FLOATING LINE LEVEL SIGNALS



*NOTE: If the output is balanced but center tapped to ground, as on all Lectrosonics receivers, do not connect Pin 3 of the XLR jack to Pin 4 of the TA5F connector.

Fig. 8

UNBALANCED LINE LEVEL SIGNALS

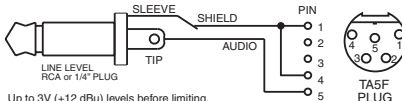

Up to 3V (+12 dBu) levels before limiting. Fully compatible with 5-pin inputs on non-ServoBias transmitters. 20k ohm resistor can be inserted in series with Pin 5 for 20 dB of attenuation to handle up to 30V (+32 dBu).

Simple Wiring - Can ONLY be used with Servo Bias Inputs:

Fig. 9

2 VOLT POSITIVE BIAS 2-WIRE ELECTRET

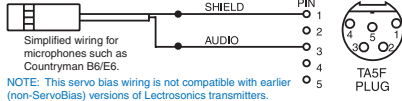

Fig. 10

2 VOLT NEGATIVE BIAS 2-WIRE ELECTRET

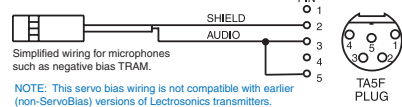
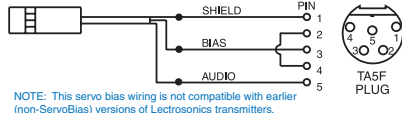

Fig. 11

4 VOLT POSITIVE BIAS 3-WIRE ELECTRET



Microphone RF Bypassing

When used on a wireless transmitter, the microphone element is in the proximity of the RF coming from the transmitter. The nature of electret microphones makes them sensitive to RF, which can cause problems with the microphone/transmitter compatibility. If the electret microphone is not designed properly for use with wireless transmitters, it may be necessary to install a chip capacitor in the mic capsule or connector to block the RF from entering the electret capsule.

Some mics require RF protection to keep the radio signal from affecting the capsule, even though the transmitter input circuitry is already RF bypassed (see schematic diagram).

If the mic is wired as directed, and you are having difficulty with squealing, high noise, or poor frequency response, RF is likely to be the cause.

The best RF protection is accomplished by installing RF bypass capacitors at the mic capsule. If this is not possible, or if you are still having problems, capacitors can be installed on the mic pins inside the TA5F connector housing.

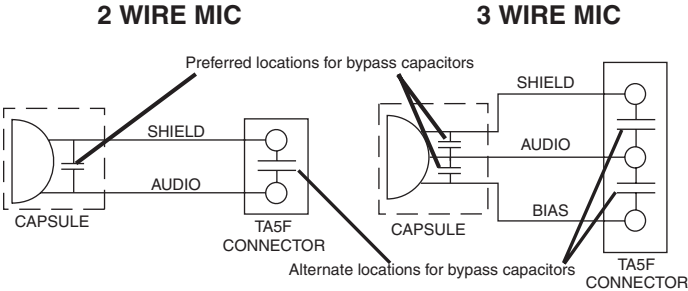

Install the capacitors as follows: Use 330 pF capacitors. Capacitors are available from Lectrosonics. Please specify the part number for the desired lead style.

Leaded capacitors: P/N 15117

Leadless capacitors: P/N SCC330P

All Lectrosonics lavalier mics are already bypassed and do not need any additional capacitors installed for proper operation.

Line Level Signals

The normal hookup for line level signals is:

- Signal Hot to pin 5
- Signal Gnd to pin 1
- Pin 4 jumped to pin 1

This allows signal levels up to 3V RMS to be applied without limiting.

If more headroom is needed, insert a 20 k resistor in series with pin 5. Put this resistor inside the TA5F connector to minimize noise pickup.

